

UNITS: millimeter

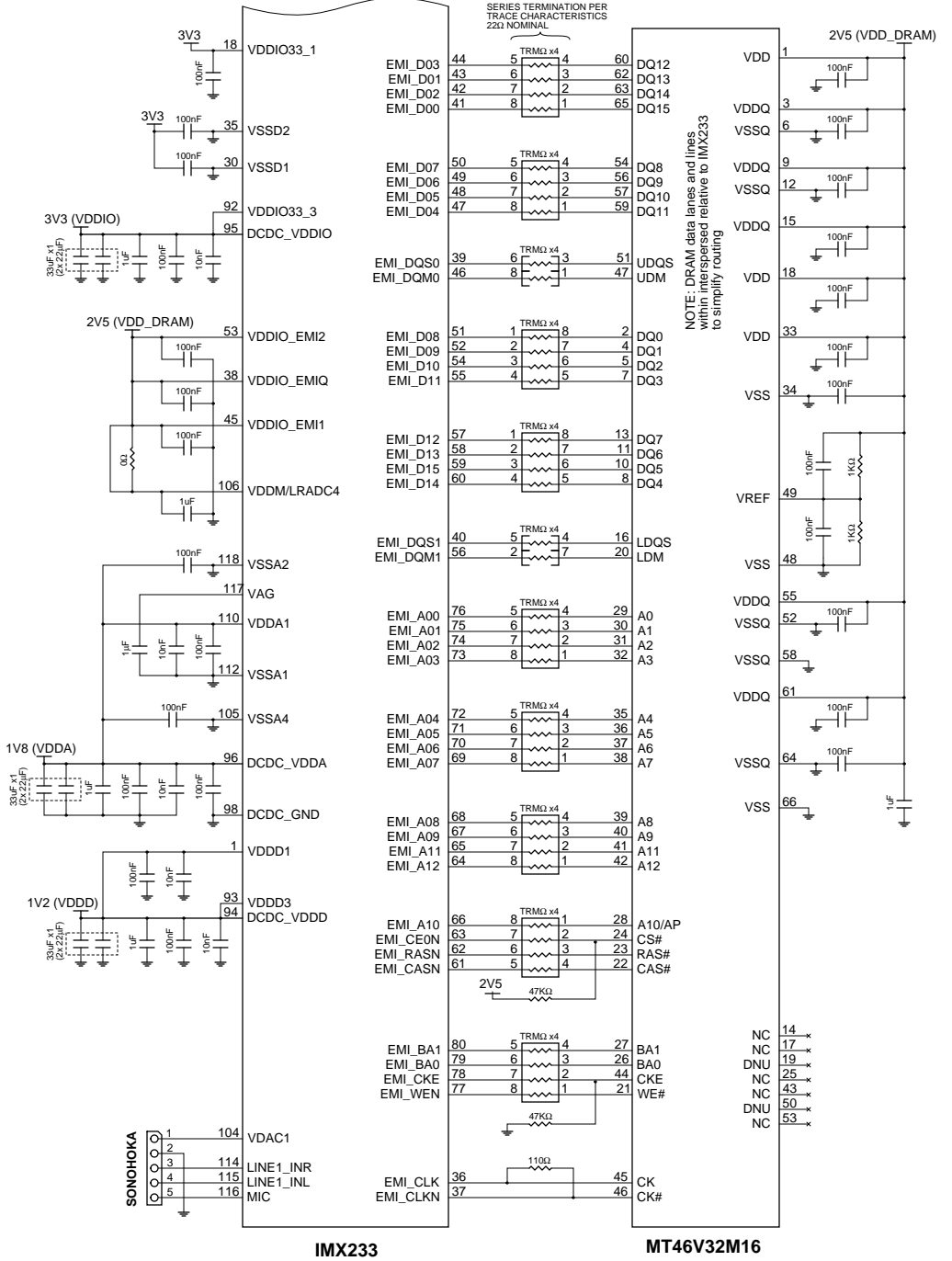
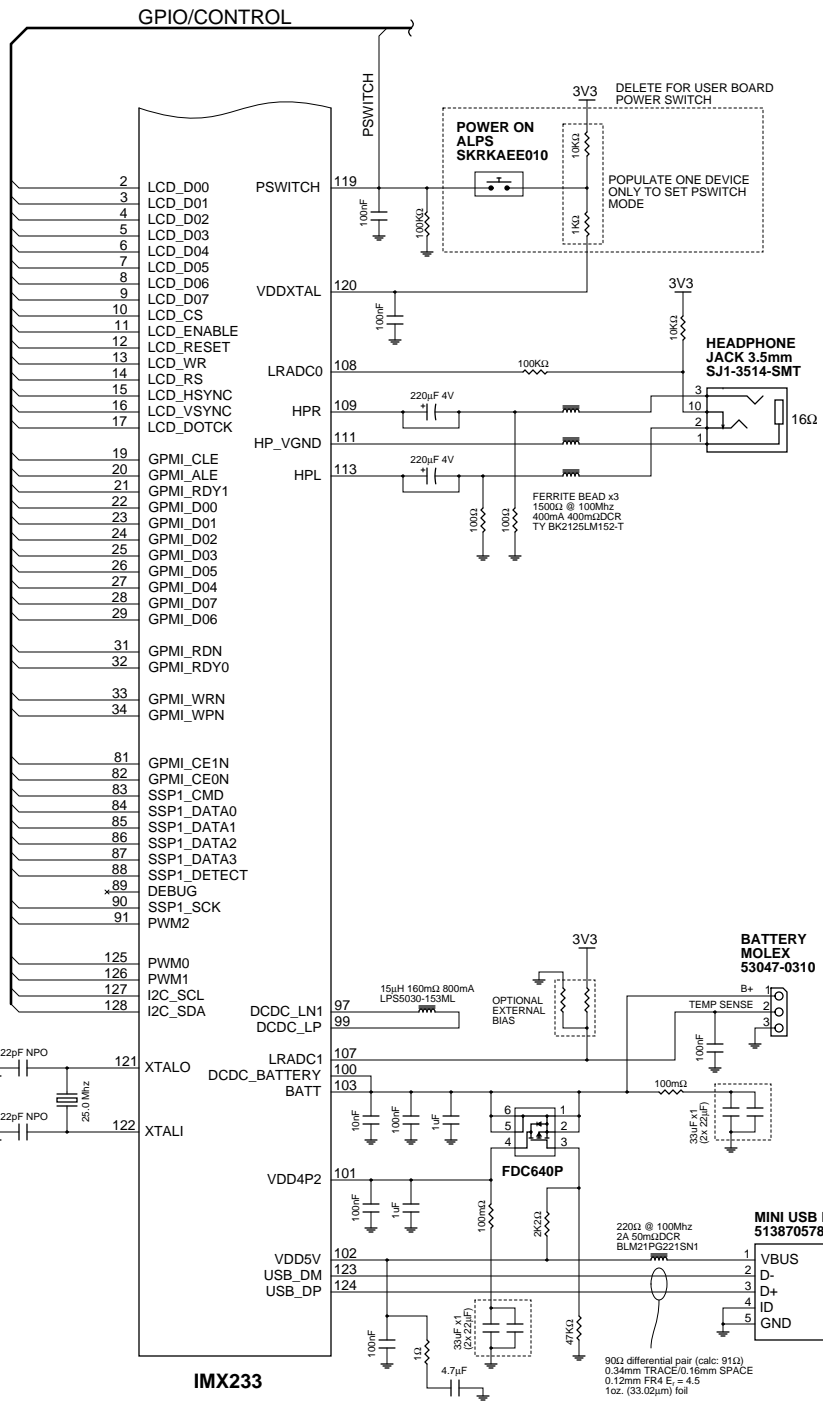

IMX233

IMX233

MT46V32M16

GPIO/CONTROL

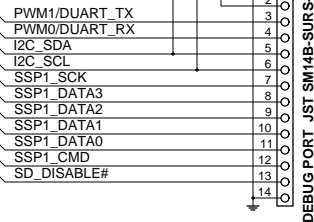
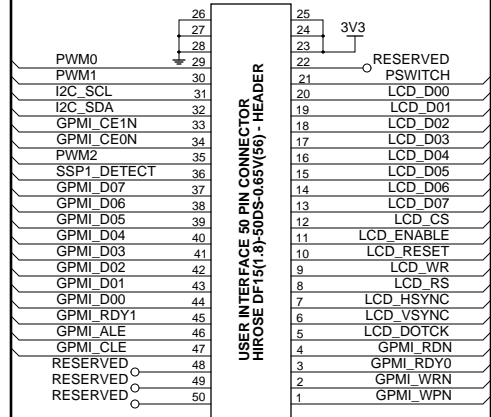

STANDALONE BOOT MODE SELECT (DEPOPULATE FOR OFF-BOARD BOOT SELECT)

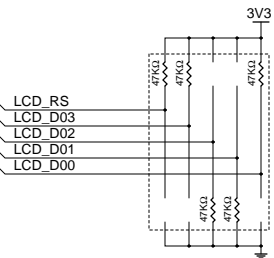

BOOT MODE				
0	0	0	0	USB
0	0	0	1	I2C
0	0	1	0	SPI1
0	0	1	1	SPI2
0	1	0	0	NAND
0	1	1	0	DEBUG
1	0	0	1	SD1/MMC1
1	0	1	0	SD2/MMC2

LCD_RS	0	OTP SELECTS BOOT MODE
LCD_RS	1	LCD PINS SELECT BOOT MODE
LCD_D04	0	NORMAL
LCD_D04	1	RESERVED
LCD_D05	0	ETM DISABLED
LCD_D05	1	ETM ENABLED

I2C EEPROM (BOOTROM PATCH) AT24C512B

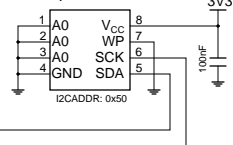

I2C_SDA
I2C_SCL

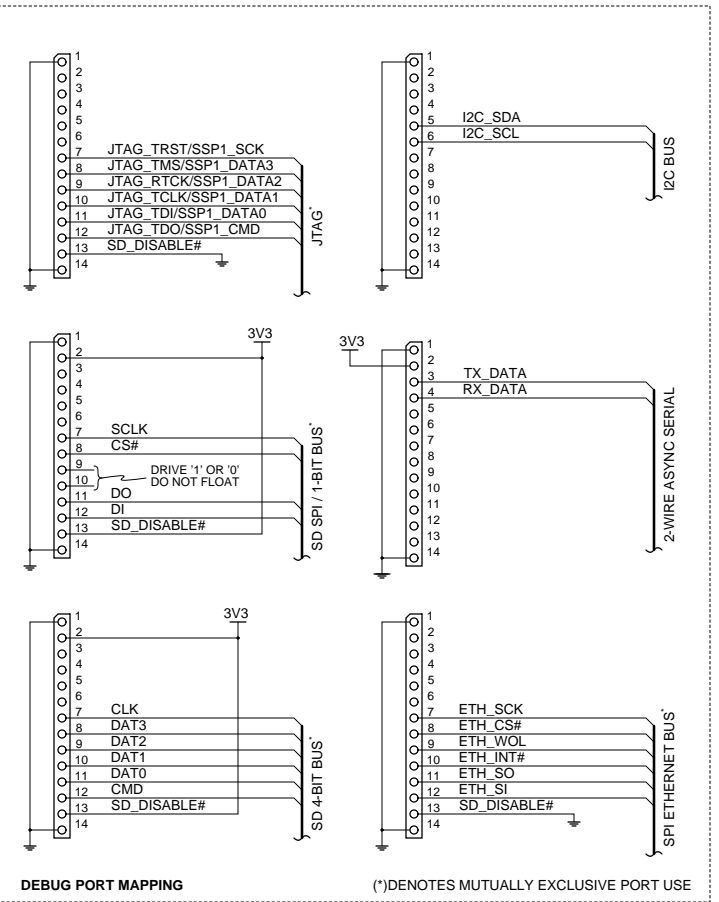

DEBUG PORT MAPPING

(*)DENOTES MUTUALLY EXCLUSIVE PORT USE

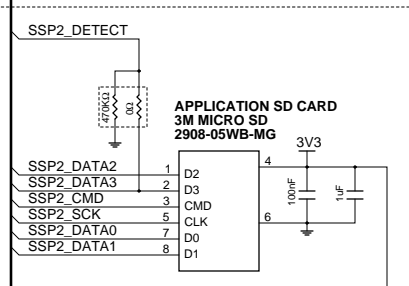

POPULATE FOR CORE BOARD APPLICATION SD OPTION

INTERNAL FIRMWARE SD CARD 3M MICRO SD 2908-05WB-MG

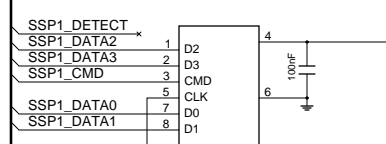

POPULATE FOR NO SD DISABLE

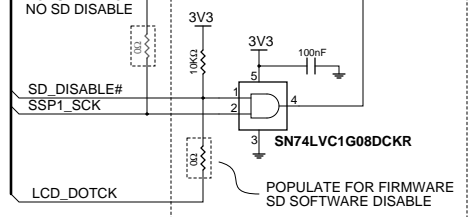

POPULATE FOR FIRMWARE SD SOFTWARE DISABLE OPTION

